

User Manual for
Full Digital Stepper Driver

Y Series Open-loop Stepper Driver

Attention: Please read this manual carefully before using the driver.

1 Introductions & Features

The Y series Open-loop drivers are divided according to the driving power, which are DM420Y, DM542Y, DM556Y, DM860Y. The Y series open loop drivers are digital stepper drivers with simple design and easy setup. By implementing the advanced stepper control technology, this stepper drive is able to power 2-phase and 4 phase stepper motors smoothly with optimal torque and low motor heating & noise. All the micro step and output current are done via DIP switches. Therefore, the Y series open loop drivers are ideal choices for applications requiring simple step & direction control of NEMA 8, 11, 14, 16, 17, 23, 24 and 34 stepper motors. And features are showing below:

- Anti-Resonance for optimal torque, extra smooth motion, low motor heating and noise
- Motor auto-identification and parameter auto-configuration for optimal torque from wide-range motors
- Step & direction (PUL/DIR) control
- Multi-Stepping for smooth motor movement
- TTL compatible and optically isolated inputs
- Input voltage DC18~36V, DC20~50V, DC36~110V(AC18~80V)
- Micro-step resolutions: 200~6400, 200~40000, 400~40000
- Output current settings: 0.3~2.2A, 1~4.2A, 1.7~5.6A, 2.4~7.2A
- Soft-start with no “jump” when powered on
- Automatic idle-current reduction
- Protections for over-voltage and over-current

2 Specifications

2.1 Operating Environment and other Specifications (Tj = 25°C/77°F)

Cooling	Natural Cooling or Forced Cooling	
Operating Environment	Environment	Avoid dust, oil fog and corrosive gases
	Ambient Temperature	0°C ~ 65°C (32°F ~ 149°F)
	Humidity	40%RH ~ 90%RH
	Operating Temperature	0°C ~ 50°C (32°F ~ 122°F)
	Vibration	10-50Hz / 0.15mm
Storage Temperature	-20°C ~ 65°C (-4°F ~ 149°F)	
Weight	120g(DM420Y), 300g(DM542Y), 300g(DM556Y), 500g(DM860Y)	

2.2 Electrical Specifications and Mechanical Specifications of different models

■ DM420Y

Electrical Specifications

Parameters	DM420Y			
	Min	Typical	Max	Unit
Output Peak Current	0.3(0.2 RMS)	-	2.2(1.6 RMS)	A
Supply Voltage	18	24	36	VDC
Logic Signal Current	7	10	15	mA
Pulse input frequency	0	-	100	kHz
Minimal pulse width	5	-	-	μ S
Minimal direction setup	5	-	-	μ S
Isolation resistance	500			M Ω

Mechanical Specifications (unit: mm)

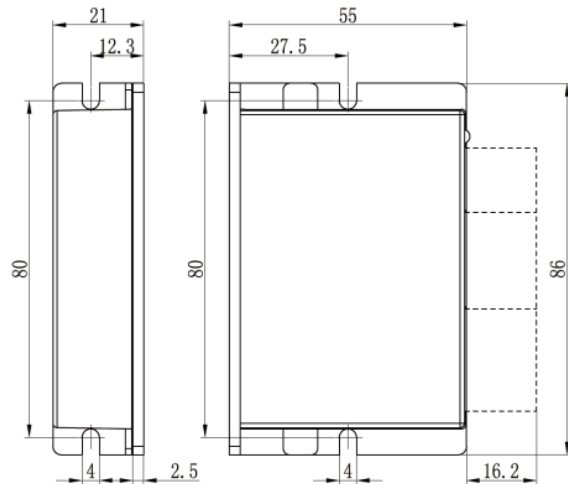

Figure 1: Mechanical specifications

Recommend use side mounting for better heat dissipation

■ DM542Y

Electrical Specifications

Parameters	DM542Y			
	Min	Typical	Max	Unit
Output Peak Current	1.0(0.71 RMS)	-	4.2(3.0 RMS)	A
Supply Voltage	20	36	50	VDC
Logic Signal Current	7	10	15	mA
Pulse input frequency	0	-	200	kHz
Minimal pulse width	2.5	-	-	μ S
Minimal direction setup	2.5	-	-	μ S
Isolation resistance	500			M Ω

Mechanical Specifications (unit: mm)

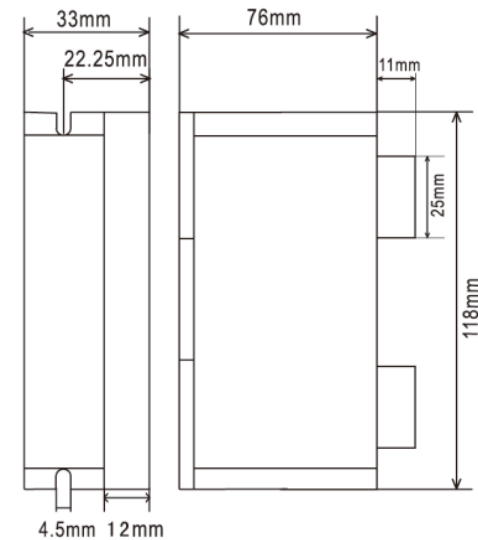

Figure 2: Mechanical specifications

Recommend use side mounting for better heat dissipation

■ DM556Y

Electrical Specifications

Parameters	DM556Y			Unit
	Min	Typical	Max	
Output Peak Current	1.7(1.2 RMS)	-	5.6(4.0 RMS)	A
Supply Voltage	20	36	50	VDC
Logic Signal Current	7	10	15	mA
Pulse input frequency	0	-	200	kHz
Minimal pulse width	2.5	-	-	μS
Minimal direction setup	2.5	-	-	μS
Isolation resistance	500			MΩ

Mechanical Specifications (unit: mm)

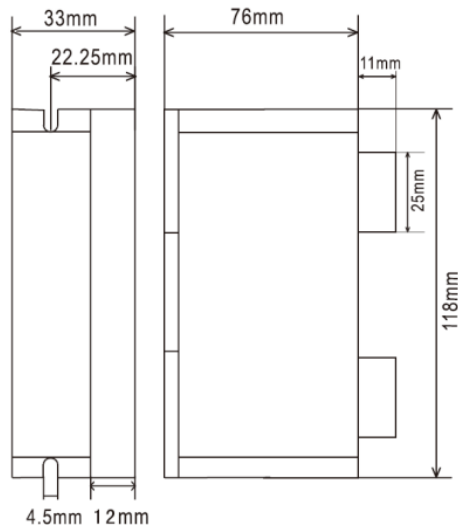

Figure 3: Mechanical specifications

Recommend use side mounting for better heat dissipation

■ DM860Y

Electrical Specifications

Parameters	DM860Y			Unit
	Min	Typical	Max	
Output Peak Current	2.4(2.0 RMS)	-	7.2(6.0 RMS)	A
Supply Voltage	18(24)	-	80(110)	VAC(VDC)
Logic Signal Current	7	10	15	mA
Pulse input frequency	0	-	200	kHz
Minimal pulse width	2.5	-	-	μS
Minimal direction setup	2.5	-	-	μS
Isolation resistance	500			MΩ

Mechanical Specifications (unit: mm)

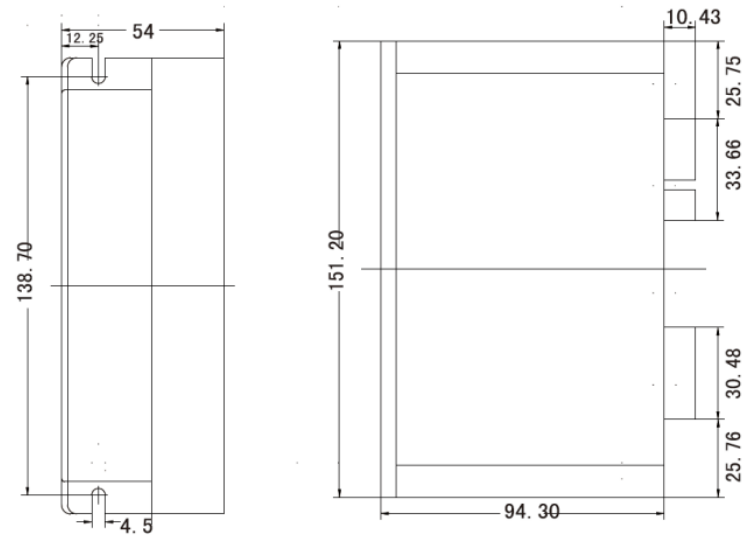

Figure4: Mechanical specifications

Recommend use side mounting for better heat dissipation

3 Pin Assignment and Description

3.1 Connector P1 Configurations

■ DM420Y:

Pin Function	Details
PU	The falling edge is valid and the pulse goes one step when the pulse goes from high to low. Built-in input resistor 384 ohms. Requirement: Low level 0~0.5V, high level is consistent with common anode end, pulse width greater than 2.5 microseconds.
DR	Used to change the direction of the motor. Built-in input resistor 384 ohms. Requirement: Low level 0~0.5V, high level is consistent with common anode end, pulse width greater than 2.5 microseconds.
MF	When it is active (low level), the motor coil current is turned off, the driver stops working, and the motor is in a free state. Built-in input resistor 384 ohms. Requirement: Low level 0~0.5V, high level is consistent with common anode end, pulse width greater than 2.5 microseconds.
+(5V)	+3.3~24V can be driven, higher than +5V must add current limiting resistor, 3.3~5V does not need to connect current limiting resistor, 24V current limiting resistor is connected to 2000 ohm, 12V current limiting resistor is connected to 820 ohm

■ DM542Y\DM556Y\DM860Y:

Pin Function	Details
PU+	Connected to the signal power supply, +5~+24V can be driven, higher than 24V need to be connected to the current limiting resistor in PU-.
PU-	The falling edge is valid and the pulse goes one step when the pulse goes from high to low. Requirements: Low level: 0~0.5V, high level 5~24V, pulse width greater than 2.5 microseconds.
DR+	Connected to the signal power supply, +5~+24V can be driven, higher than 24V need to be connected to the current limiting resistor in DR-.
DR-	Used to change the direction of the motor. Requirements: Low level: 0~0.5V, high level 5~24V, pulse width greater than 2.5 microseconds.
MF+	Connected to the signal power supply, +5~+24V can be driven, higher than 24V need to be connected to the current limiting resistor in MF-.
MF-	When it is active (low level), the motor coil current is turned off, the driver stops working, and the motor is in a free state.

4 Wiring

4.1 Control Signal Connector (P1) Interface

The Y series open-loop drivers can accept differential and single-ended inputs (including open-collector and PNP output). The Y series open-loop drivers 3 optically isolated logic inputs which are located on connector P1 to accept line drive control signals. These inputs are isolated to minimize or eliminate electrical noises coupled with the drive control signals. Recommend using line drive control signals to increase noise immunity for the drive in interference environments. In the following figures, connections to open-collector and PNP signals are illustrated.

+5V : R1=0, R2=0
 +12V : R1=510Ω , R2=820Ω
 +24V : R1=1.2KΩ , R2=1.8KΩ

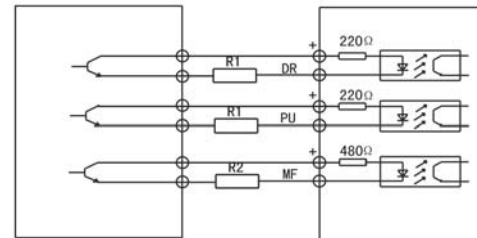

Controller Drive

Figure 5: Differential wiring method

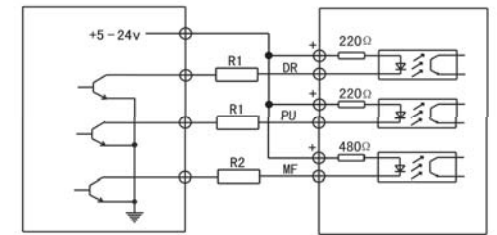

Controller Drive

Figure 6: Independent common anode wiring method

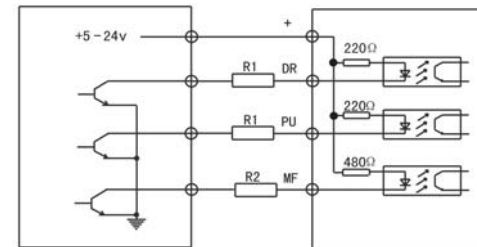

Figure 7: Common anode wiring method

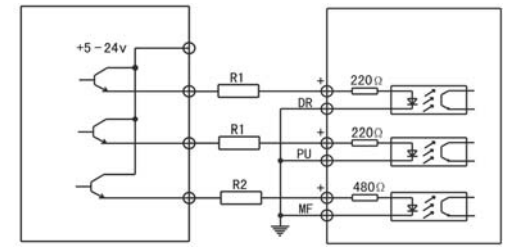

Figure 8: Independent common cathode wiring method

4.2 Connections of 4-lead Motor

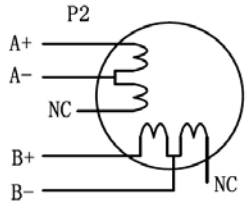

Figure 9: 4-lead Motor Connections

4.3 Connections of 6-lead Motor

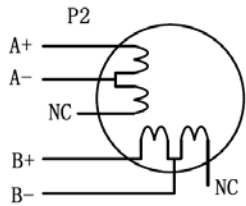

Figure10: 6-lead motor half coil (higher speed) connections

4.4 Connections of 8-lead Motor

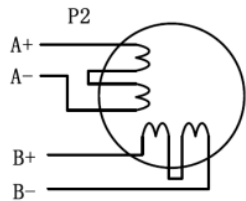

Figure 12: 8-lead motor series connections

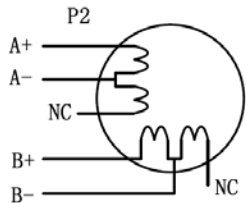

Figure14: 8-lead motor half coil

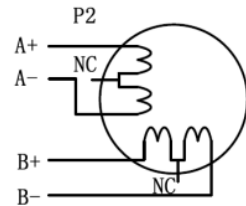

Figure 11: 6-lead motor full coil (higher torque) connections

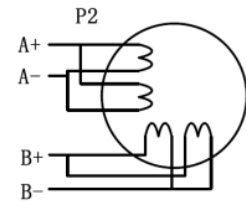

Figure 13: 8-lead motor parallel connections

5 Frequently Asked Questions

Symptoms	Possible Problems
Motor is not rotating	No power
	Fault condition exists
	The driver is disabled
Motor rotates in the wrong direction	The direction signal level is reverse
Erratic motor motion	Control signal is too weak
	Control signal is interfered
	Wrong motor connection
Motor stalls during acceleration	Something wrong with motor coil
	Current setting is too small
	Motor is undersized for the application
	Acceleration is set too high
Excessive motor and driver heating	Power supply voltage too low
	Inadequate heat sinking / cooling
	Motor current setting is too high

6 Warranty

STEPPERONLINE® warrants its products against defects in materials and workmanship for a period of 12 months from shipment. During the warranty period, STEPPERONLINE will either, at its option, repair or replace products which proved to be defective. To obtain warranty service, a returned material authorization number (RMA) must be obtained before returning product for service.

Exclusions: The above warranty does not extend to any product damaged by reasons of improper or inadequate handlings by customer, improper or inadequate customer wirings, unauthorized modification or misuse, or operation beyond the electrical specifications of the product and/or operation beyond environmental specifications for the product.

For more detailed descriptions, please refer to the specifications on our website: www.omc-stepperonline.com.