

ISS23-10

Integrate Stepper Servo Motor

Manual



Contents

1. Overview	- 1 -
2. Features	- 1 -
3. Ports Introduction	- 2 -
3.1 ALM signal output ports.....	- 2 -
3.2 Control Signal Input Ports.....	- 2 -
3.3 Power Interface Ports.....	- 3 -
4. Technological Index	- 4 -
5. Connections to Control Signal	- 5 -
5.1 Connections to Common Anode.....	- 5 -
5.2 Connections to Common Cathode.....	- 6 -
5.3 Connections to Differential Signal.....	- 7 -
5.4 Connections to 232 Serial Communication Interface.....	- 8 -
5.5 Sequence Chart of Control Signals.....	- 8 -
6. DIP Switch Setting	- 9 -
6.1 microsteps Setting.....	- 9 -
6.2 Activate Edge Setting.....	- 10 -
6.3 Running Direction Setting.....	- 10 -
7. Faults alarm and LED flicker frequency	- 10 -
8. Appearance and Installation Dimensions	- 12 -
9. Parameter Setting	- 13 -
10. Processing Methods to Common Problems and Faults	- 17 -
10.1 Power on power light off.....	- 17 -
10.2 Power on red alarm light on.....	- 17 -
10.3 Red alarm light on after the motor running a small angle.....	- 18 -
10.4 After input pulse signal but the motor not running.....	- 18 -

1. Overview

The ISS23-XX Integrated Stepper Servo Motor is merged the stepper servo driver and motor together. This motor system integrates the servo control technology into the digital stepper drive perfectly. And this product adopts an optical encoder with high speed position sampling feedback of 50 μ s, once the position deviation appears, it will be fixed immediately. This product is compatible the advantages of the stepper drive and the servo drive, such as lower heat, less vibration, fast acceleration, and so on.

2. Features

- ◆ Integrated compact size for saving mounting space
- ◆ Without losing step, High accuracy in positioning
- ◆ 100% rated output torque
- ◆ Variable current control technology, High current efficiency
- ◆ Small vibration, Smooth and reliable moving at low speed
- ◆ Accelerate and decelerate control inside, Great improvement in smoothness of starting or stopping the motor
- ◆ User-defined microsteps
- ◆ No adjustment in general applications
- ◆ Over current, over voltage and over position error protection
- ◆ Green light means running while red light means protection or off line

3. Ports Introduction

3.1 ALM signal output ports

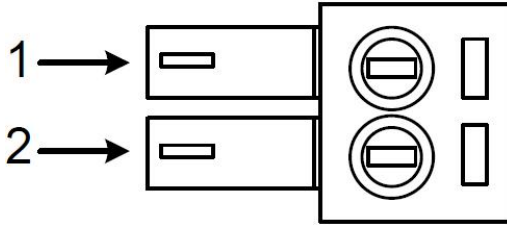

Symbol	Name	Remark
ALM+	Alarm output +	
ALM-	Alarm output -	
PED-	Arrive position output-	
PED+	Arrive position output+	

3.2 Control Signal Input Ports

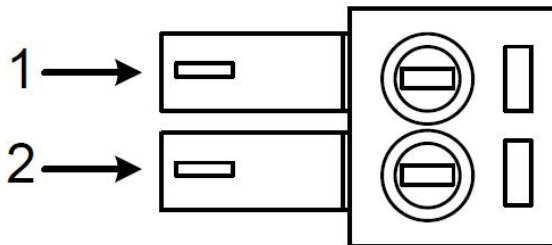

Symbol	Name	Remark
ENA-	Enable signal -	Compatible with 5V or 24V
ENA+	Enable signal +	
DIR-	Direction signal-	
DIR+	Direction signal+	
PUL-	Pulse signal -	
PUL+	Pulse signal +	

3.3 Power Interface Ports

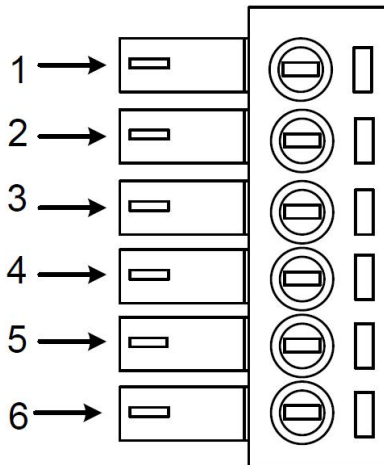

Symbol	Name
VCC	Input power
GND	Input power ground

4. Technological Index

Input Voltage		24~50VDC(36V Typical)
Output Current		4.5A 20KHz PWM
Pulse Frequency max		200K
Communication rate		57.6Kbps
Protection		Over current peak value 8A±10% Over voltage value 80V The over position error range can be set through the HISU
Environment Specifications	Environment	Avoid dust, oil fog and corrosive gases
	Operating Temperature	70°C MAX
	Storage Temperature	-20°C~+65°C
	Humidity	40~90%RH
	Cooling method	Natural cooling or forced air cooling

5. Connections to Control Signal

5.1 Connections to Common Anode

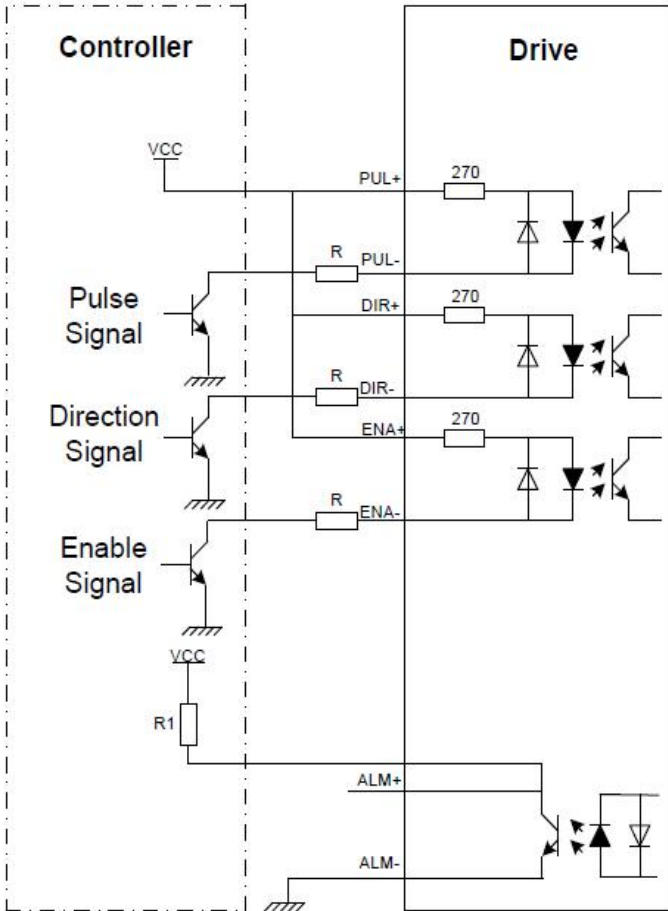

Remark:

VCC is compatible with 5V or 24V;

R(3~5K) must be connected to control signal terminal.

5.2 Connections to Common Cathode

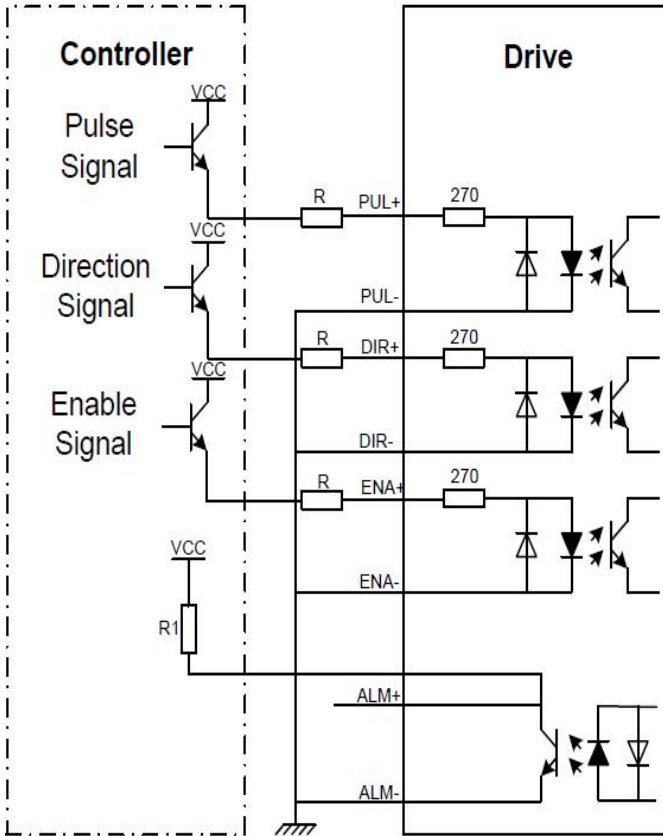

Remark:

VCC is compatible with 5V or 24V;

R(3~5K) must be connected to control signal terminal.

5.3 Connections to Differential Signal

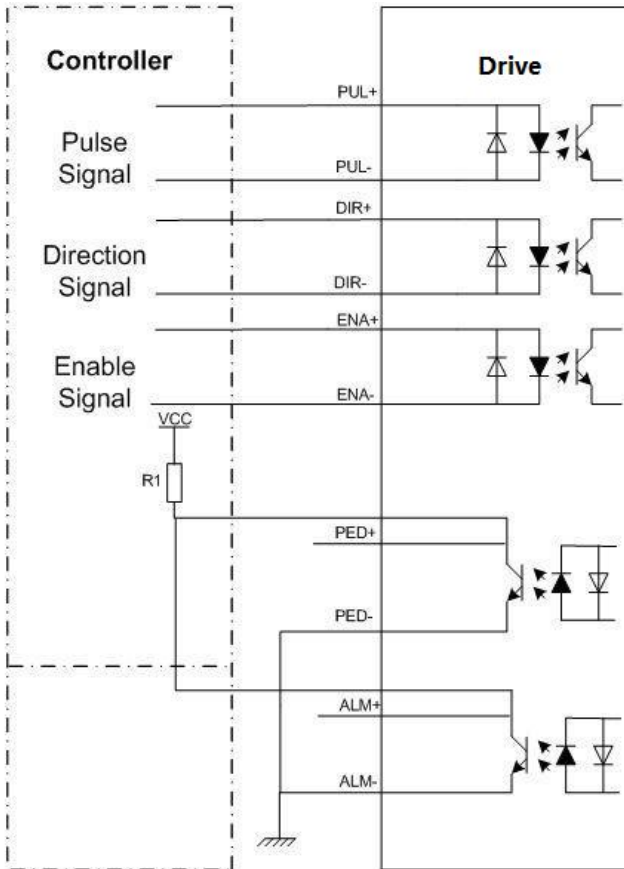

Remark:

VCC is compatible with 5V or 24V;

R(3~5K) must be connected to control signal terminal.

5.4 Connections to 232 Serial Communication Interface

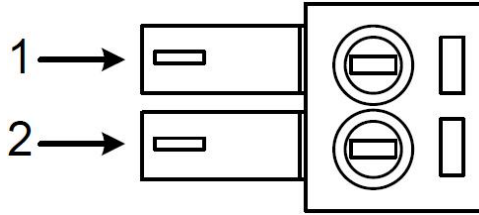

Definition	Remark
NC	Reserved
RX	Receive Data
GND	Power Ground
TX	Transmit Data
+5V	Power Supply to HISU

5.5 Sequence Chart of Control Signals

In order to avoid some fault operations and deviations, PUL, DIR and ENA should abide by some rules, shown as following diagram:

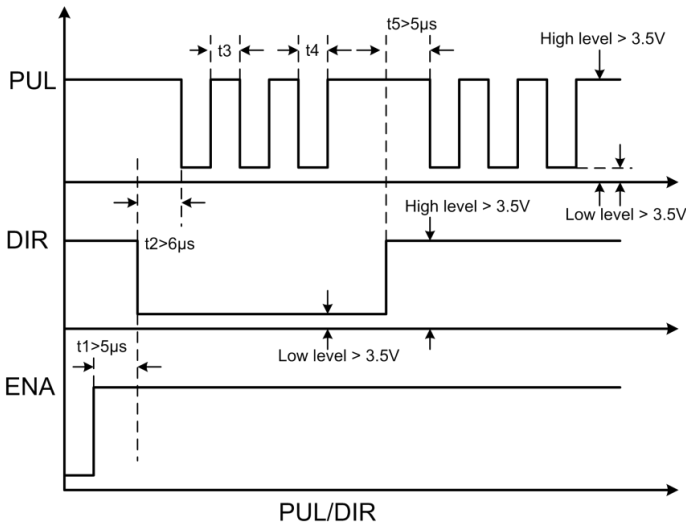

Remark:

- a. t1: ENA must be ahead of DIR by at least 5μs. Usually, ENA+ and ENA- are NC (not connected).
- b. t2: DIR must be ahead of PUL active edge by 6μs to ensure correct direction;
- c. t3: Pulse width not less than 2.5μs;
- d. t4: Low level width not less than 2.5μs.

6. DIP Switch Setting

6.1 microsteps Setting

The microsteps setting is in the following table, while SW1,SW,SW,SW4 are all on, the internal default microsteps inside is activate this ratio can be setting through the HISU.

Dial switch Microsteps	SW1	SW2	SW3	SW4
Default	on	on	on	on
800	off	on	on	on
1600	on	off	on	on
3200	off	off	on	on
6400	on	on	off	on
12800	off	on	off	on
25600	on	off	off	on
51200	off	off	off	on
1000	on	on	on	off

2000	off	on	on	off
4000	on	off	on	off
5000	off	off	on	off
8000	on	on	off	off
10000	off	on	off	off
20000	on	off	off	off
40000	off	off	off	off

6.2 Running Direction Setting

SW5 is used for setting the activate edge of the input signal, “off” means the activate edge is the rising edge, while “on” is the falling edge.

6.3 Activate Edge Setting

SW6 is used for setting the running direction, “off” means CCW, while “on” means CW.

7. Faults alarm and LED flicker frequency

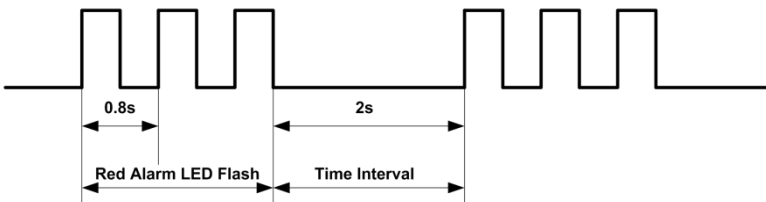

Flicker Frequency	Description to the Faults
1	Error occurs when the motor coil current exceeds the drive's current limit.
2	Voltage reference error in the drive
3	Parameters upload error in the drive
4	Error occurs when the input voltage exceeds the drive's voltage limit.
5	Error occurs when the actual position following error exceeds the limit which is set by the position error limit .

8. Appearance and Installation Dimensions

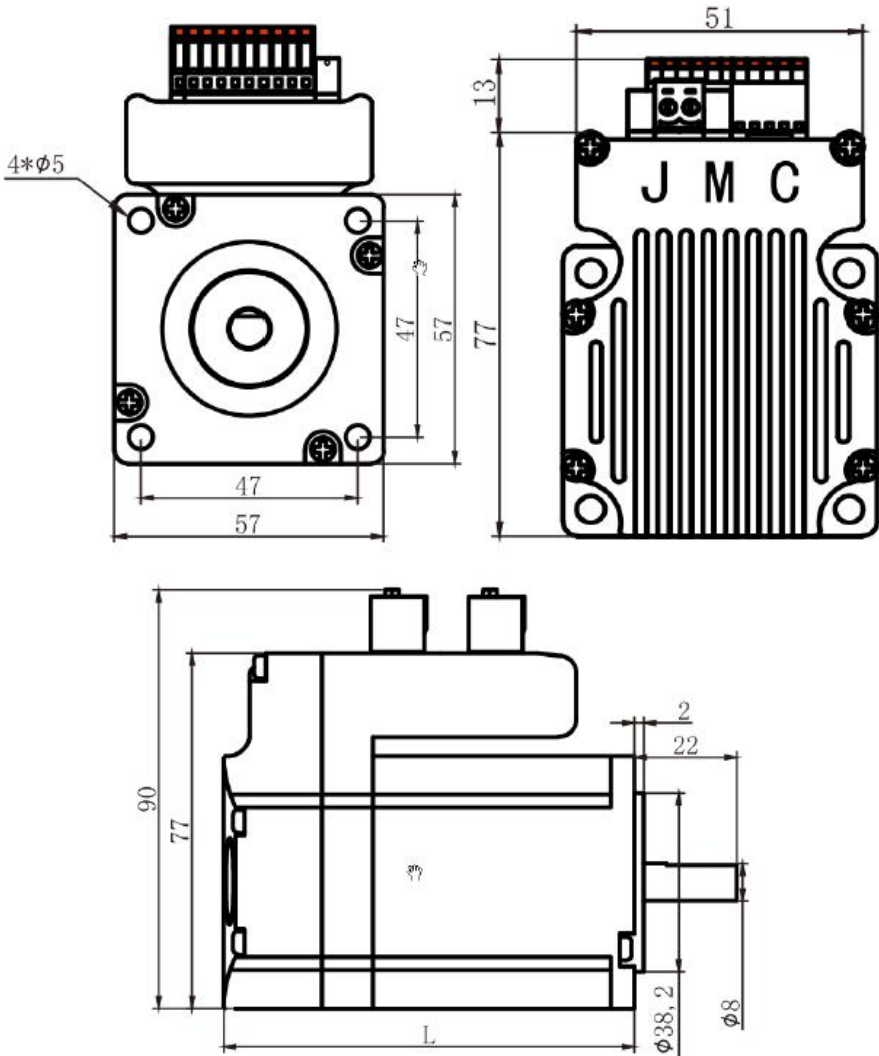

Model	Length(mm)
ISS23-10	85
ISS23-20	106

9. Parameter Setting

The parameter setting method of ISS23-XX drive is to use a HISU adjuster through the 232 serial communication ports, only in this way can we setting the parameters we want. There are a set of best default parameters to the corresponding motor which are carefully adjusted by our engineers, users only need refer to the following table, specific condition and set the correct parameters.

Actual value = Set value the corresponding dimension

Mode	Definition	Range	Dimension	Drive Restart	Default Value
P1	Current loop Kp	0—4000	1	N	1000
P2	Current loop Ki	0-1000	1	N	100
P3	Damping coefficient	0-1000	1	N	100
P4	Position loop Kp	0—4000	1	N	1300
P5	Position loop Ki	0-1000	1	N	250
P6	Speed loop Kp	0-3000	1	N	50
P7	Position loop Ki	0-1000	1	N	10
P8	Open loop current	0-40	0.1	N	30
P9	Close loop current	0-30	0.1	N	20

P10	Alarm level	0-1	1	N	0
P11	Reserved				
P12	Stop lock enable	0-1	1	N	0
P13	Enable signal level	0-1	1	N	0
P14	Arrival level	0-1	1	N	1
P15	Reserved				
P16	Position error limit	0-3000	10	N	1000
P17	Reserved				
P18	Reserved				
P19	Speed smoothness	0-10	1	N	0
P20	User-defined p/r	4-1000	50	Y	8

There are total 20 parameter configurations, use the HISU to download the configured parameters to the drive, the detail descriptions to every parameter configuration are as follows:

Item	Description
Current loop Kp	Increase Kp to make current rise fast. Proportional Gain determines the response of the drive to setting command. Low Proportional Gain provides a stable system (doesn't oscillate), has low stiffness, and the current error, causing poor performances in tracking current setting command in each step. Too large proportional gain values will cause oscillations and unstable system.
Current loop Ki	Adjust Ki to reduce the steady error. Integral Gain helps the drive to overcome static current errors.
Damping coefficient	A low or zero value for Integral Gain may have current errors at rest. Increasing the integral gain can reduce the error. If the Integral Gain is too large, the system may "hunt" (oscillate) around the desired position.
	This parameter is used to change the damping coefficient in case of the desired operating state is under resonance frequency.
Position loop Kp	The PI parameters of the position loop. The default values are suitable for most of the application, you don't need to change them. Contact us if you have any question.
Position loop Ki	
Speed loop Kp	The PI parameters of the speed loop. The default values are suitable for most of the application, you don't need to change them. Contact us if you have any question.
Speed loop Ki	

<p>Open loop current</p> <p>Close loop current</p>	<p>This parameter affects the dynamic torque of the motor. (The actual current = open loop current + close loop current)</p>
<p>Alarm Control</p>	<p>This parameter is set to control the Alarm optocoupler output transistor. 0 means the transistor is cut off when the system is in normal working, but when it comes to fault of the drive, the transistor becomes conductive. 1 means opposite to 0.</p>
<p>Stop lock enable</p>	<p>This parameter is set to enable the stop clock of the drive. 1 means enable this function while 0 means disable it.</p>
<p>Enable Control</p> <p>Arrival Control</p>	<p>This parameter is set to control the Enable input signal level, 0 means low, while 1 means high.</p> <p>This parameter is set to control the Arrival optocoupler output transistor. 0 means the transistor is cut off when the drive satisfies the arrival command, but when it comes to not, the transistor becomes conductive. 1 means opposite to 0.</p>
<p>Position error limit</p>	<p>The limit of the position following error. When the actual position error exceeds this value, the drive will go into error mode and the fault output will be activated. (The actual value = the set value - 10)</p>

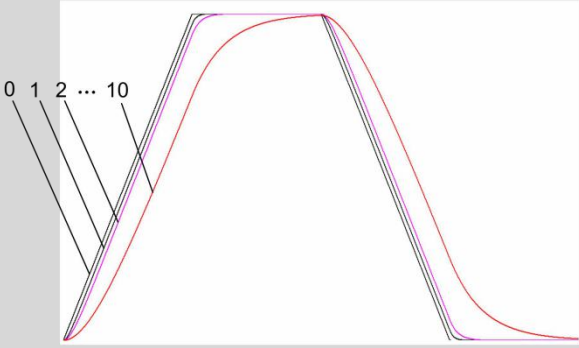
<p>Speed Smoothness</p>	<p>This parameter is set to control the smoothness of the speed of the motor while acceleration or deceleration, the larger the value, the smoother the speed in acceleration or deceleration.</p>
	
<p>User-defined p/r</p>	<p>This parameter is set of user-defined pulse per revolution, the internal default microsteps inside is activate while SW3 SW4 SW5 SW6 are all on, users can also set the microsteps by the outer DIP switches. (The actual microsteps = the set value 50)</p>

10.Frequently Asked Questions

10.1 Power on power light off

■No power input, please check the power supply circuit. The voltage is too low.

10.2 Power on red alarm light on

■Please check the motor feedback signal and if the motor is connected with the drive.

■ The stepper servo drive is over voltage or under voltage. Please lower or increase the input voltage.

10.3 Red alarm light on after the motor running a small angle

■ Please check the motor phase wires if they are connected correctly, if not, please refer to the 3.4 Power Ports.

■ Please check the parameter in the drive if the poles of the motor and the encoder lines are corresponding with the real parameters, if not, set them correctly.

■ Please check if the frequency of the pulse signal is too fast, thus the motor may be out of its rated speed, and lead to position error.

10.4 After input pulse signal but the motor not running

■ Please check the input pulse signal wires are connected in reliable way.

■ Please make sure the input pulse mode is corresponding with the real input mode.